

Data sheet | Item number: 2250-1201

TOPJOB®S miniature feedthrough terminal block with Push-buttons; DIN-15 rail mount; 2-conductor; 3.5 mm wide; gray

www.wago.com/2250-1201

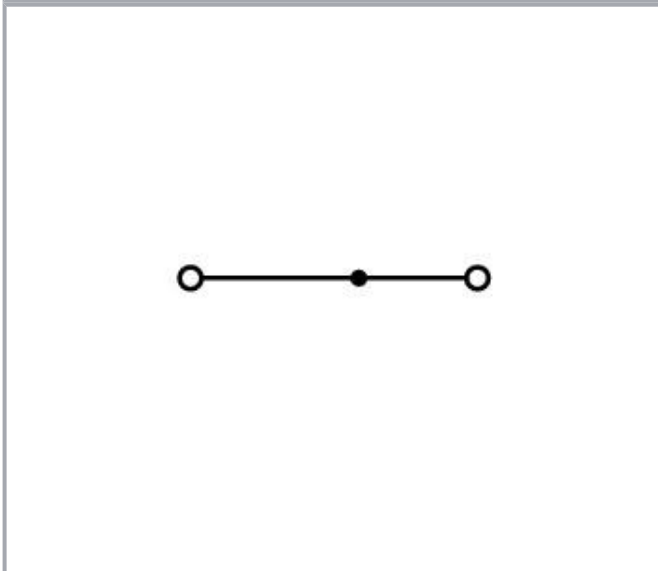
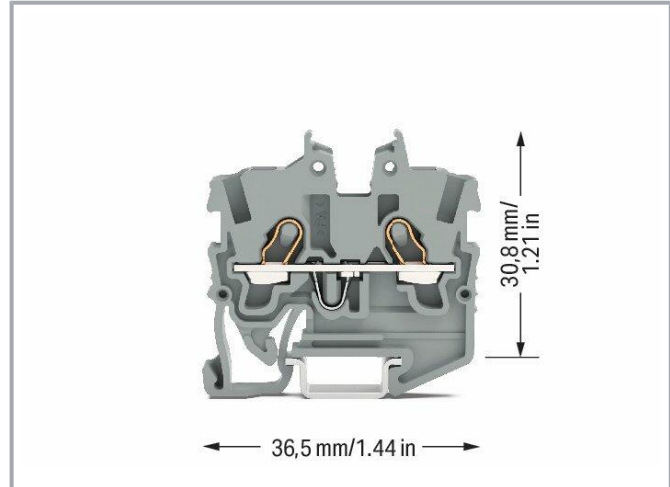
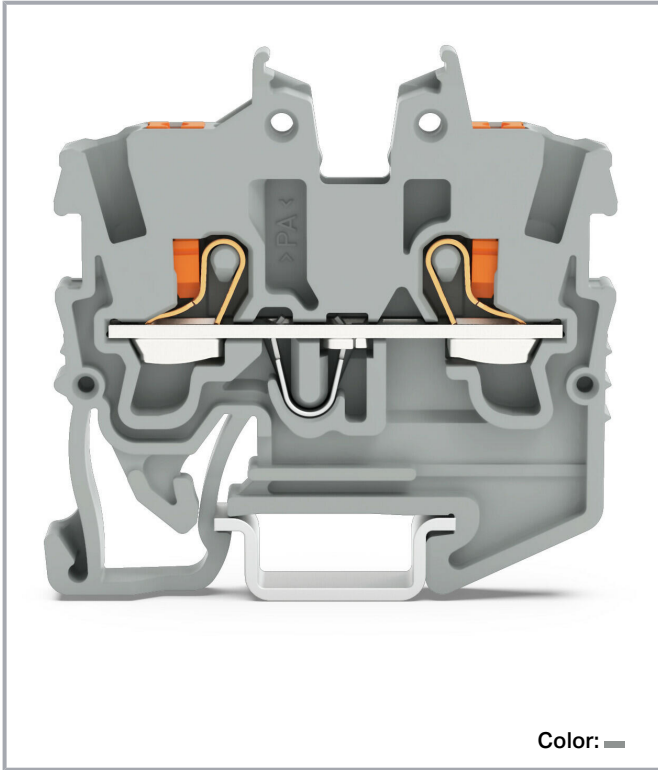

Subject to changes. Please also observe the further product documentation!

WAGO Corporation
Germantown, WI 53022
Phone: 1-800-DIN-RAIL (346-7245) | Fax: (262) 255-6222
Email: info.us@wago.com | Web: www.wago.us

Do you have any questions about our products?
We are always happy to take your call at (262) 255-6222 or 1 800-DIN-RAIL.



Data

Electrical data

IEC Approvals

Ratings per	IEC/EN 60947-7-1
Rated voltage (III / 3)	500 V
Rated surge voltage (III/3)	6 kV
Rated current	13.5 A
Rated current 2	17.5 A
Legend (ratings)	(III / 3) ≙ Overvoltage category III / Pollution degree 3

UL Approvals

Approvals per	UL 1059
Rated voltage UL (Use Group B)	300 V
Rated current UL (Use Group B)	10 A
Rated voltage UL (Use Group C)	300 V
Rated current UL (Use Group C)	10 A

CSA Approvals

Approvals per	C22.2 No 158
Rated voltage CSA (Use Group B)	300 V
Rated current CSA (Use Group B)	10 A
Rated voltage CSA (Use Group C)	300 V
Rated current CSA (Use Group C)	10 A

Ex information

Rated voltage EN (Ex e II)	352 V
Rated current (Ex e II)	13.5 A
Rated current (Ex e II) with jumper	12 A

Connection data

Connection technology	Push-in CAGE CLAMP®
Actuation type	Push-in Push-button Open Tool Slot
Connectable conductor materials	Copper

Subject to changes. Please also observe the further product documentation!

WAGO Corporation
Germantown, WI 53022
Phone: 1-800-DIN-RAIL (346-7245) | Fax: (262) 255-6222
Email: info.us@wago.com | Web: www.wago.us

Do you have any questions about our products?
We are always happy to take your call at (262) 255-6222 or 1 800-DIN-RAIL.



	Copper
Nominal cross-section	1 mm ²
Solid conductor	0.14 ... 1.5 mm ² / 24 ... 16 AWG
Solid conductor; push-in termination	0.5 ... 1.5 mm ² / 20 ... 16 AWG
Fine-stranded conductor	0.14 ... 1.5 mm ² / 24 ... 16 AWG
Fine-stranded conductor; with insulated ferrule	0.14 ... 0.75 mm ² / 24 ... 18 AWG
Fine-stranded conductor; with ferrule; push-in termination	0.5 ... 0.75 mm ² / 20 ... 18 AWG
Note (conductor cross-section)	Depending on the conductor characteristic, a conductor with a smaller cross-section can also be inserted via push-in termination.
Strip length	9 ... 11 mm / 0.35 ... 0.43 inch
Total number of connection points	2
Total number of potentials	1
Number of levels	1
Wiring direction	Front-entry wiring
Number of jumper slots	1

Physical data

Width	3.5 mm / 0.138 inch
Height	34.1 mm / 1.343 inch
Depth from upper edge of DIN-rail	27.9 mm / 1.098 inch

Mechanical data

Design	horizontal type
Mounting type	DIN-15 rail
Marking level	Center/side marking

Material data

Color	gray
Insulation material	Polyamide (PA66)
Flammability class per UL94	V0
Fire load	0.046 MJ
Weight	2.5 g

Commercial data

Packaging type	BOX
Country of origin	DE
GTIN	4055143965200

Subject to changes. Please also observe the further product documentation!

WAGO Corporation
 Germantown, WI 53022
 Phone: 1-800-DIN-RAIL (346-7245) | Fax: (262) 255-6222
 Email: info.us@wago.com | Web: www.wago.us





Do you have any questions about our products?
 We are always happy to take your call at (262) 255-6222 or 1 800-DIN-RAIL.

Customs tariff number





8536904000

Approvals / Certificates

Ex-Approvals

Logo	Approval	Additional Approval Text	Certificate name
	AEx Underwriters Laboratories Inc.	UL 60079	E185892
	ATEX Physikalisch Technische Bundesanstalt	EN IEC 60079-0	PTB 19 ATEX 1019 U (II 2G Ex eb IIC Gb or I M 2 EX eb I Mb)
	CCCEX CQST/CNEx	CNCA-C23-01	2020312313000289
	IECEX Physikalisch Technische Bundesanstalt	IEC 60079	IECEX PTB 19.0050 U (Ex eb IIC Gb or EX eb I Mb)

Country specific Approvals

Logo	Approval	Additional Approval Text	Certificate name
	CCA DEKRA Certification B.V.	EN 60998	NTR NL 7840
	CCA DEKRA Certification B.V.	EN 60947	NTR NL 7839
	CSA CSA	C22.2 No. 158	80034182
	KEMA/KEUR DEKRA Certification B.V.	EN 60947	71- 113930
	KEMA/KEUR DEKRA Certification B.V.	EN 60998	71- 113957

Subject to changes. Please also observe the further product documentation!



UL-Approvals

Logo	Approval	Additional Approval Text	Certificate name
	cURus Underwriters Laboratories Inc.	UL 1059	E45172- 20200212

Required accessories

End plates



	Item no.: 2050-1291 End and intermediate plate; 1.1 mm thick; gray	www.wago.com/2050-1291
---------------------------------------------------------------------------------	------------------------------------------------------------------------------	--------------------------------------------------------------------

Optional accessories



Mounting

	Item no.: 249-101 Screwless end stop; 6 mm wide; for WMB markers; gray	www.wago.com/249-101
------------------------------------------------------------------------------------	----------------------------------------------------------------------------------	----------------------------------------------------------------

Ferrules

	Item no.: 216-241 Ferrule; Sleeve for 0.5 mm ² / 20 AWG; insulated; electro-tin plated; electrolytic copper; gastight crimped; acc. to DIN 46228, Part 4/09.90; white	www.wago.com/216-241
	Item no.: 216-242 Ferrule; Sleeve for 0.75 mm ² / 18 AWG; insulated; electro-tin plated; electrolytic copper; gastight crimped; acc. to DIN 46228, Part 4/09.90; gray	www.wago.com/216-242
	Item no.: 216-243 Ferrule; Sleeve for 1 mm ² / AWG 18; insulated; electro-tin plated; electrolytic copper; gastight crimped; acc. to DIN 46228, Part 4/09.90; red	www.wago.com/216-243

Carrier rail

	Item no.: 210-111 Steel carrier rail; 15 x 5.5 mm; 1 mm thick; 2 m long; slotted; according to EN 60715; silver-colored	www.wago.com/210-111
	Item no.: 210-295 Steel carrier rail; 15 x 5.5 mm; 1 mm thick; 2 m long; unslotted; according to EN 60715; silver-colored	www.wago.com/210-295
	Item no.: 210-296 Aluminum carrier rail; 15 x 5.5 mm; 1 mm thick; 2 m long; unslotted; similar to EN 60715; silver-colored	www.wago.com/210-296

Tools

Subject to changes. Please also observe the further product documentation!

WAGO Corporation
Germantown, WI 53022
Phone: 1-800-DIN-RAIL (346-7245) | Fax: (262) 255-6222
Email: info.us@wago.com | Web: www.wago.us

Do you have any questions about our products?
We are always happy to take your call at (262) 255-6222 or 1 800-DIN-RAIL.



Item no.: 210-647
Operating tool; Blade: 2.5 x 0.4 mm; with a partially insulated shaft; multicoloured

www.wago.com/210-647



Item no.: 210-648
Operating tool; Blade: 2.5 x 0.4 mm; with a partially insulated shaft; angled; short

www.wago.com/210-648



Item no.: 210-719
Operating tool; Blade: 2.5 x 0.4 mm; with a partially insulated shaft

www.wago.com/210-719

Marking accessories



Item no.: 2009-113
WMB-Inline; for Smart Printer; 2300 pieces on roll; plain; snap-on type; white

www.wago.com/2009-113



Item no.: 2009-113/000-002
WMB-Inline; for Smart Printer; 2300 pieces on roll; plain; snap-on type; yellow

www.wago.com/2009-113/000-002



Item no.: 2009-113/000-005
WMB-Inline; for Smart Printer; 2300 pieces on roll; plain; snap-on type; red

www.wago.com/2009-113/000-005



Item no.: 2009-113/000-006
WMB-Inline; for Smart Printer; 2300 pieces on roll; plain; snap-on type; blue

www.wago.com/2009-113/000-006



Item no.: 2009-113/000-007
WMB-Inline; for Smart Printer; 2300 pieces on roll; plain; snap-on type; gray

www.wago.com/2009-113/000-007



Item no.: 2009-113/000-012
WMB-Inline; for Smart Printer; 2300 pieces on roll; plain; snap-on type; orange

www.wago.com/2009-113/000-012



Item no.: 2009-113/000-017
WMB-Inline; for Smart Printer; 2300 pieces on roll; plain; snap-on type; light green

www.wago.com/2009-113/000-017



Item no.: 2009-113/000-023
WMB-Inline; for Smart Printer; 2300 pieces on roll; plain; snap-on type; green

www.wago.com/2009-113/000-023



Item no.: 2009-113/000-024
WMB-Inline; for Smart Printer; 2300 pieces on roll; plain; snap-on type; violet

www.wago.com/2009-113/000-024



Item no.: 2009-191
Group marker carrier

www.wago.com/2009-191

















Item no.: 793-3501
WMB marking card; as card; plain; snap-on type; white

www.wago.com/793-3501















Testing accessories

Item no.: 2009-174















Subject to changes. Please also observe the further product documentation!

	TOPJOB®S test plug adapter; for test plug 4 mm Ø; for testing TOPJOB®S terminal blocks; gray	www.wago.com/2009-174
	Item no.: 2009-182 TOPJOB®S testing tap; tool-free; 12 AWG max; for testing TOPJOB®S terminal blocks; gray	www.wago.com/2009-182
	Item no.: 210-136 Test plug; 2 mm Ø; with 500 mm cable	www.wago.com/210-136
	Item no.: 210-137 Test plug; 2.3 mm Ø; with 500 mm cable	www.wago.com/210-137
Push-in type wire jumper		
	Item no.: 2009-402 TOPJOB®S wire jumper; insulated; 60 mm long; conductor cross section 0.75 mm ² ; suitable for 2000 and 2020 series terminal blocks; gray	www.wago.com/2009-402
	Item no.: 2009-404 TOPJOB®S wire jumper; insulated; 110 mm long; conductor cross section 0.75 mm ² ; suitable for 2000 and 2020 series terminal blocks; gray	www.wago.com/2009-404
	Item no.: 2009-406 TOPJOB®S wire jumper; insulated; 250 mm long; conductor cross section 0.75 mm ² ; suitable for 2000 and 2020 series terminal blocks; gray	www.wago.com/2009-406
Jumpers		
	Item no.: 2000-402 TOPJOB®S jumper; for 2000 series; insulated; 2-way; light-gray	www.wago.com/2000-402
	Item no.: 2000-402/000-005 TOPJOB®S jumper; for 2000 series; insulated; 2-way; red	www.wago.com/2000-402/000-005
	Item no.: 2000-402/000-006 TOPJOB®S jumper; for 2000 series; insulated; 2-way; blue	www.wago.com/2000-402/000-006
	Item no.: 2000-402/000-018 TOPJOB®S jumper; for 2000 series; insulated; 2-way; green-yellow	www.wago.com/2000-402/000-018
	Item no.: 2000-403 TOPJOB®S jumper; for 2000 series; insulated; 3-way; light-gray	www.wago.com/2000-403
	Item no.: 2000-403/000-005 TOPJOB®S jumper; for 2000 series; insulated; 3-way; red	www.wago.com/2000-403/000-005
	Item no.: 2000-403/000-006 TOPJOB®S jumper; for 2000 series; insulated; 3-way; blue	www.wago.com/2000-403/000-006
	Item no.: 2000-404 TOPJOB®S jumper; for 2000 series; insulated; 4-way; light-gray	www.wago.com/2000-404

Subject to changes. Please also observe the further product documentation!





	Item no.: 2000-404/000-005 TOPJOB®S jumper; for 2000 series; insulated; 4-way; red	www.wago.com/2000-404/000-005
	Item no.: 2000-404/000-006 TOPJOB®S jumper; for 2000 series; insulated; 4-way; blue	www.wago.com/2000-404/000-006
	Item no.: 2000-405 TOPJOB®S jumper; for 2000 series; insulated; 5-way; light-gray	www.wago.com/2000-405
	Item no.: 2000-405/000-005 TOPJOB®S jumper; for 2000 series; insulated; 5-way; red	www.wago.com/2000-405/000-005
	Item no.: 2000-405/000-006 TOPJOB®S jumper; for 2000 series; insulated; 5-way; blue	www.wago.com/2000-405/000-006
	Item no.: 2000-405/011-000 TOPJOB®S jumper; Wye configuration; for 2000 series; insulated; 3-way (1-3-5); light-gray	www.wago.com/2000-405/011-000
	Item no.: 2000-406 TOPJOB®S jumper; for 2000 series; insulated; 6-way; light-gray	www.wago.com/2000-406
	Item no.: 2000-406/000-005 TOPJOB®S jumper; for 2000 series; insulated; 6-way; red	www.wago.com/2000-406/000-005
	Item no.: 2000-406/000-006 TOPJOB®S jumper; for 2000 series; insulated; 6-way; blue	www.wago.com/2000-406/000-006
	Item no.: 2000-406/020-000 TOPJOB®S jumper; Delta configuration; for 2000 series; insulated; 6-way (1-2, 3-4, 5-6); light-gray	www.wago.com/2000-406/020-000
	Item no.: 2000-407 TOPJOB®S jumper; for 2000 series; insulated; 7-way; light-gray	www.wago.com/2000-407
	Item no.: 2000-407/000-005 TOPJOB®S jumper; for 2000 series; insulated; 7-way; red	www.wago.com/2000-407/000-005
	Item no.: 2000-407/000-006 TOPJOB®S jumper; for 2000 series; insulated; 7-way; blue	www.wago.com/2000-407/000-006
	Item no.: 2000-408 TOPJOB®S jumper; for 2000 series; insulated; 8-way; light-gray	www.wago.com/2000-408
	Item no.: 2000-408/000-005 TOPJOB®S jumper; for 2000 series; insulated; 8-way; red	www.wago.com/2000-408/000-005

Subject to changes. Please also observe the further product documentation!

	Item no.: 2000-408/000-006 TOPJOB®S jumper; for 2000 series; insulated; 8-way; blue	www.wago.com/2000-408/000-006
	Item no.: 2000-409 TOPJOB®S jumper; for 2000 series; insulated; 9-way; light-gray	www.wago.com/2000-409
	Item no.: 2000-409/000-005 TOPJOB®S jumper; for 2000 series; insulated; 9-way; red	www.wago.com/2000-409/000-005
	Item no.: 2000-409/000-006 TOPJOB®S jumper; for 2000 series; insulated; 9-way; blue	www.wago.com/2000-409/000-006
	Item no.: 2000-410 TOPJOB®S jumper; for 2000 series; insulated; 10-way; light-gray	www.wago.com/2000-410
	Item no.: 2000-410/000-005 TOPJOB®S jumper; for 2000 series; insulated; 10-way; red	www.wago.com/2000-410/000-005
	Item no.: 2000-410/000-006 TOPJOB®S jumper; for 2000 series; insulated; 10-way; blue	www.wago.com/2000-410/000-006
	Item no.: 2000-433 TOPJOB®S jumper; for 2000 series; insulated; 2-way (1-3); light-gray	www.wago.com/2000-433
	Item no.: 2000-433/000-005 TOPJOB®S jumper; for 2000 series; insulated; 2-way (1-3); red	www.wago.com/2000-433/000-005
	Item no.: 2000-433/000-006 TOPJOB®S jumper; for 2000 series; insulated; 2-way (1-3); blue	www.wago.com/2000-433/000-006
	Item no.: 2000-434 TOPJOB®S jumper; for 2000 series; insulated; 2-way (1-4); light-gray	www.wago.com/2000-434
	Item no.: 2000-435 TOPJOB®S jumper; for 2000 series; insulated; 2-way (1-5); light-gray	www.wago.com/2000-435
	Item no.: 2000-436 TOPJOB®S jumper; for 2000 series; insulated; 2-way (1-6); light-gray	www.wago.com/2000-436
	Item no.: 2000-437 TOPJOB®S jumper; for 2000 series; insulated; 2-way (1-7); light-gray	www.wago.com/2000-437
	Item no.: 2000-438 TOPJOB®S jumper; for 2000 series; insulated; 2-way (1-8); light-gray	www.wago.com/2000-438

Subject to changes. Please also observe the further product documentation!



	Item no.: 2000-439 TOPJOB®S jumper; for 2000 series; insulated; 2-way (1-9); light-gray	www.wago.com/2000-439
	Item no.: 2000-440 TOPJOB®S jumper; for 2000 series; insulated; 2-way (1-10); light-gray	www.wago.com/2000-440
	Item no.: 2009-110 Marking strips; for Smart Printer; on reel; not stretchable; plain; snap-on type; white	www.wago.com/2009-110
	Item no.: 210-103 Wire commoning chain; insulated; black	www.wago.com/210-103
	Item no.: 210-123 Wire commoning chain; insulated; blue	www.wago.com/210-123

Downloads

Documentation

Additional Information

Technical explanations	Apr 3, 2019	pdf 2.2 MB	Download
------------------------	-------------	---------------	----------

CAD files

CAD data

2D/3D Models 2250-1201	URL	Download
------------------------	-----	----------

CAE data

EPLAN Data Portal 2250-1201	URL	Download
	URL	Download
ZUKEN Portal 2250-1201	URL	Download

Environmental Product Compliance

Compliance Search

Environmental Product Compliance 2250-1201 2-conductor miniature through terminal block; with push-button; 1 mm ² ; with test port; side and center marking; for DIN-15 rail; Push-in CAGE CLAMP®, 1,00 mm ² ; gray	URL	Download
----------------------------------------------------------------------------------------------------------------------------------------------------------------------------------------------------------------------------------------------	-----	----------

Subject to changes. Please also observe the further product documentation!

WAGO Corporation
Germantown, WI 53022
Phone: 1-800-DIN-RAIL (346-7245) | Fax: (262) 255-6222
Email: info.us@wago.com | Web: www.wago.us

Do you have any questions about our products?
We are always happy to take your call at (262) 255-6222 or 1 800-DIN-RAIL.

Installation Notes

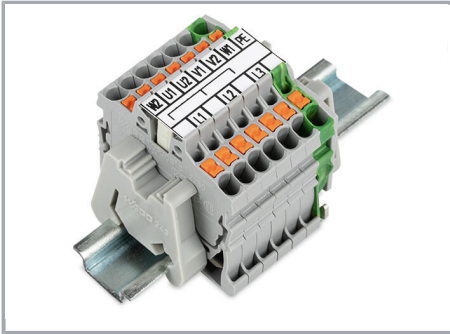

Conductor termination



Insert solid conductors via push-in termination.



Insert ferruled conductors via push-in termination.

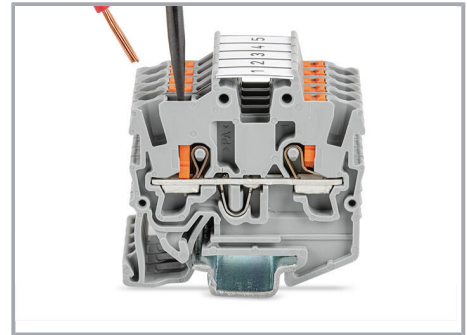

Insert fine-stranded conductors via operating tool.

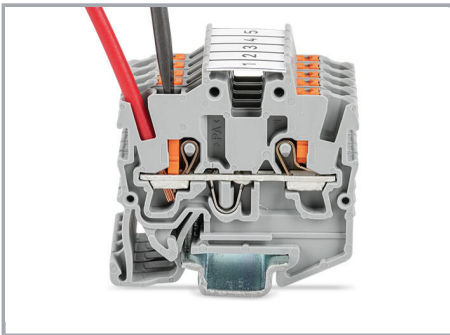

Remove all conductors via operating tool.

Commoning

Subject to changes. Please also observe the further product documentation!

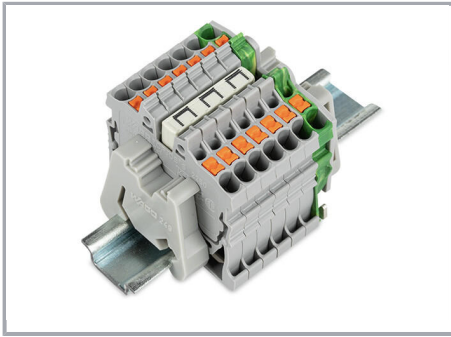

Insert a jumper (delta jumper) and push down until it hits the backstop (picture shows terminal blocks with push-buttons).

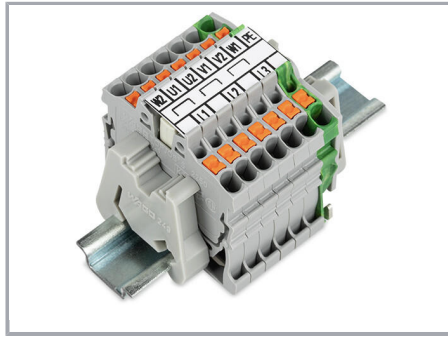

Marking strip (2009-110) inserted in the marking slot with jumper symbols of the inserted jumper (picture shows terminal blocks with push-buttons)

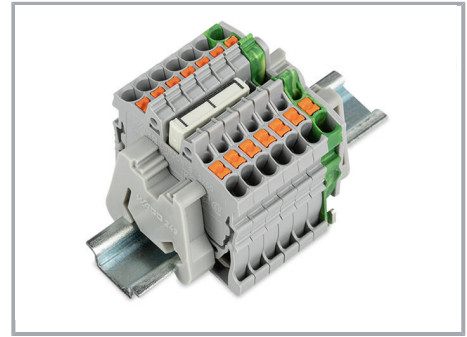

Insert a jumper (star point jumper) and push down until it hits the backstop (picture shows terminal blocks with push-buttons).

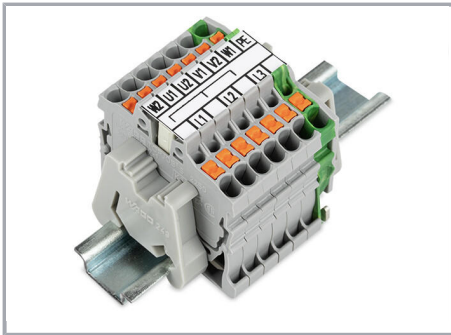

Marking strip (2009-110) inserted in the marking slot with jumper symbols of the inserted jumper (2000-405/011-000 Delta Jumper) (picture shows terminal blocks with push-buttons)

Testing

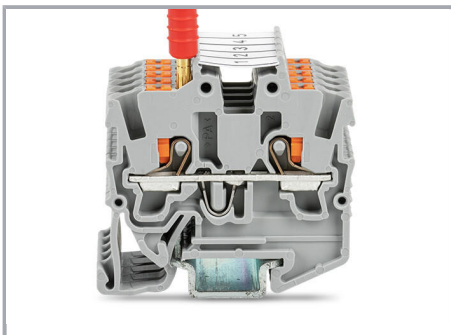

Testing with a 2 mm Ø 210-136 Test Plug (max. 42 V).

Marking

Subject to changes. Please also observe the further product documentation!

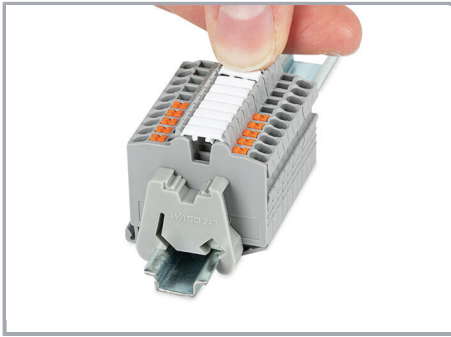

Snapping a WMB marking strip into a marker slot.

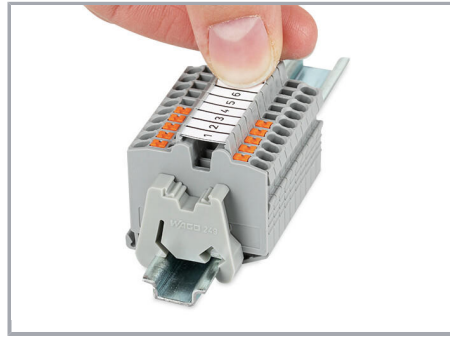

Snapping a marking strip (2009-110) into a marker slot.

Product family

TOPJOB® S

TOPJOB® S: In various industrial applications and modern building installations, WAGO's wide and versatile range of rail-mount terminal blocks provides more than just reliable electrical connections.

[Show all products from the family](#)

Subject to changes. Please also observe the further product documentation!

WAGO Corporation
Germantown, WI 53022
Phone: 1-800-DIN-RAIL (346-7245) | Fax: (262) 255-6222
Email: info.us@wago.com | Web: www.wago.us

Do you have any questions about our products?
We are always happy to take your call at (262) 255-6222 or 1 800-DIN-RAIL.